

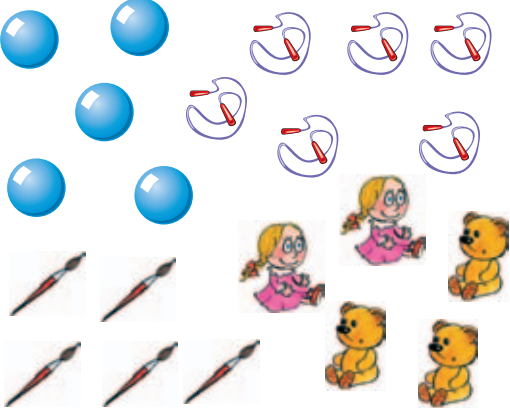

















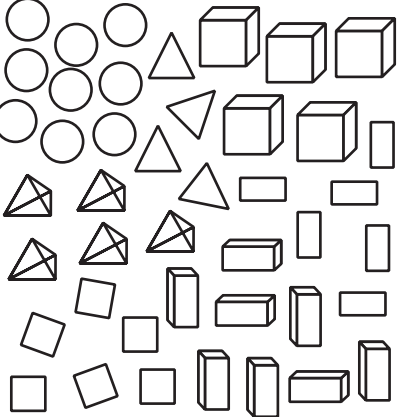

2. LEIA HULGAD JA VÄRVI DIAGRAMMID.

	<table border="1" style="width: 100%; height: 100%; border-collapse: collapse;"> <tr><td style="background-color: #00aaff; width: 100px; height: 30px;"></td><td></td><td></td><td></td><td></td></tr> <tr><td></td><td></td><td></td><td></td><td></td></tr> <tr><td></td><td></td><td></td><td></td><td></td></tr> <tr><td></td><td></td><td></td><td></td><td></td></tr> <tr><td></td><td></td><td></td><td></td><td></td></tr> <tr><td></td><td></td><td></td><td></td><td></td></tr> <tr><td></td><td></td><td></td><td></td><td></td></tr> </table> <div style="display: flex; justify-content: space-around; margin-top: 5px;">      </div>																																			
	<table border="1" style="width: 100%; height: 100%; border-collapse: collapse;"> <tr><td></td><td></td><td></td><td></td><td></td></tr> <tr><td></td><td></td><td></td><td></td><td></td></tr> <tr><td></td><td></td><td></td><td></td><td></td></tr> <tr><td></td><td></td><td></td><td></td><td></td></tr> <tr><td></td><td></td><td></td><td></td><td></td></tr> <tr><td></td><td></td><td></td><td></td><td></td></tr> <tr><td></td><td></td><td></td><td></td><td></td></tr> </table> <div style="display: flex; justify-content: space-around; margin-top: 5px;">      </div>																																			

	<table border="1" style="width: 100%; height: 100%; border-collapse: collapse;"> <tr><td></td><td></td><td></td><td></td><td></td><td></td><td></td></tr> <tr><td></td><td></td><td></td><td></td><td></td><td></td><td></td></tr> <tr><td></td><td></td><td></td><td></td><td></td><td></td><td></td></tr> <tr><td></td><td></td><td></td><td></td><td></td><td></td><td></td></tr> <tr><td></td><td></td><td></td><td></td><td></td><td></td><td></td></tr> <tr><td></td><td></td><td></td><td></td><td></td><td></td><td></td></tr> <tr><td></td><td></td><td></td><td></td><td></td><td></td><td></td></tr> </table> <div style="display: flex; justify-content: space-around; margin-top: 5px;">        </div>																																																	

VÖRDLE HULKI.

3. VAATLE JA LEIA RÜHMITAMISE TUNNUS.

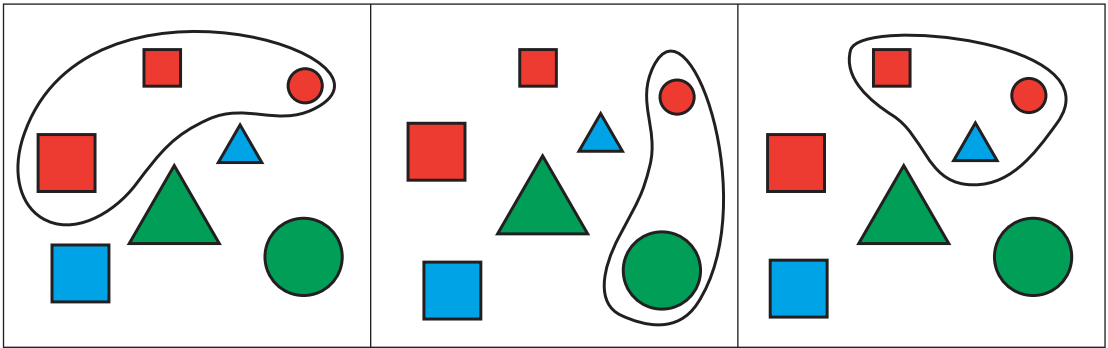

4. VAATLE JA RÜHMITA KOLMEL VIISIL NAGU EELMISES ÜLESANDES.

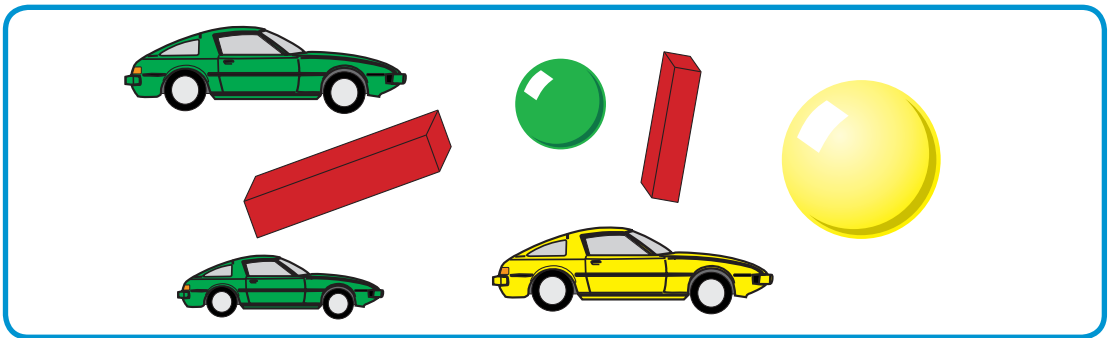

5. LEIA PAARID.



6. LEIA JA VÖRDLE HULKI.



7. VAATLE JA VÖRDLE.

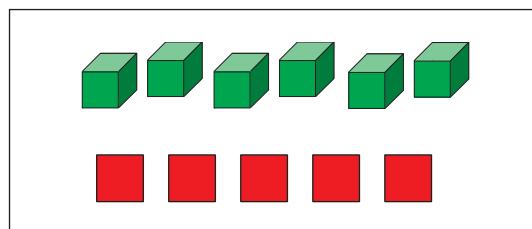
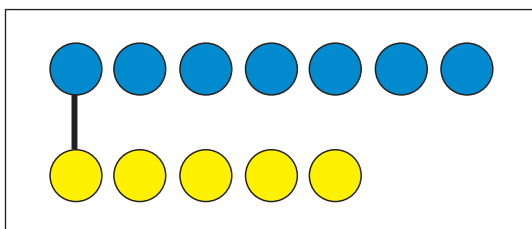

8. VÖRDLE.

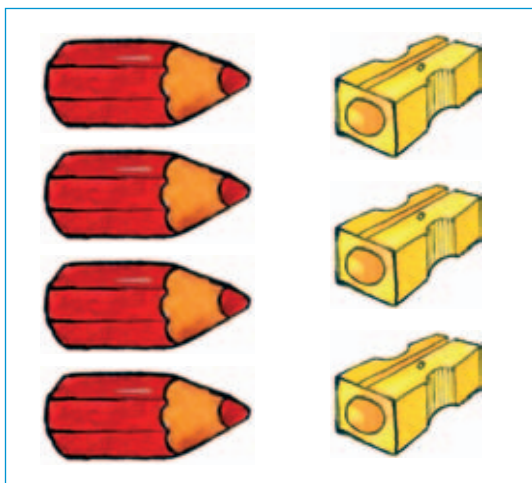

R \_ HK \_ M

V \_ H \_ M

V \_ RDS \_ LT

KIRJUTA PUUDUVAD TÄHED.



9. VÄRVI.

1 VÖRRA ROHKEM

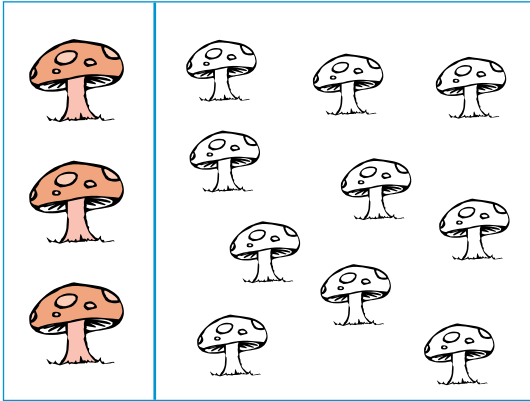

2 VÖRRA ROHKEM

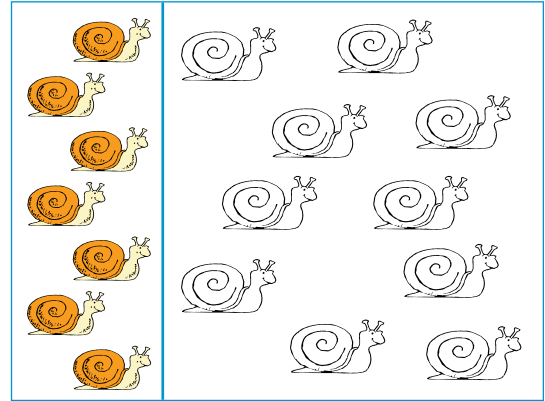

1 VÖRRA VÄHEM

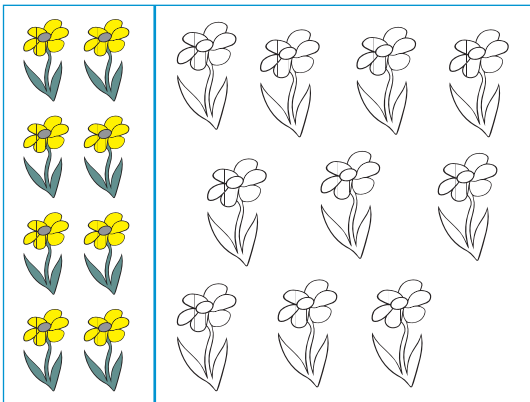

3 VÖRRA VÄHEM

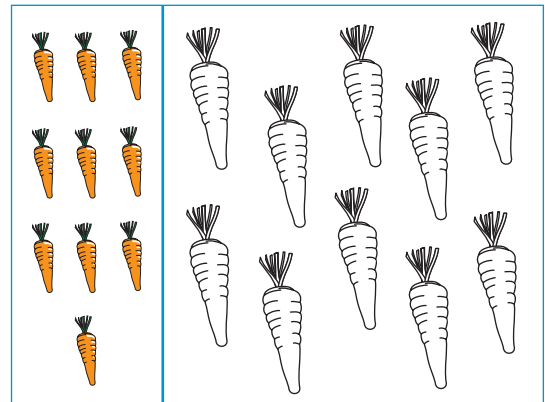

VÖRDSELT

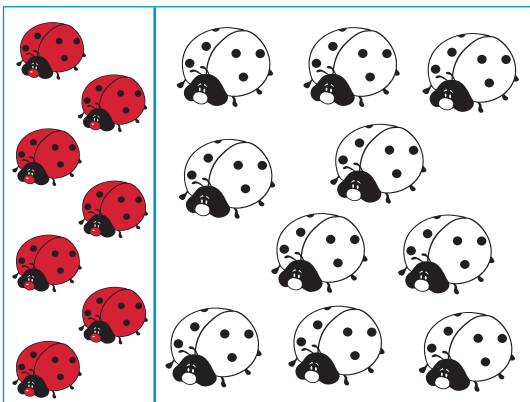

VÖRDSELT

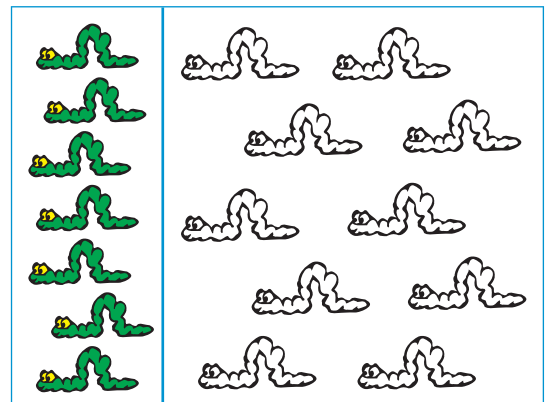

**10. MÕTLE, MILLISE KUJUNDI SAAD EHTADA ANTUD KUUPIDEST.**

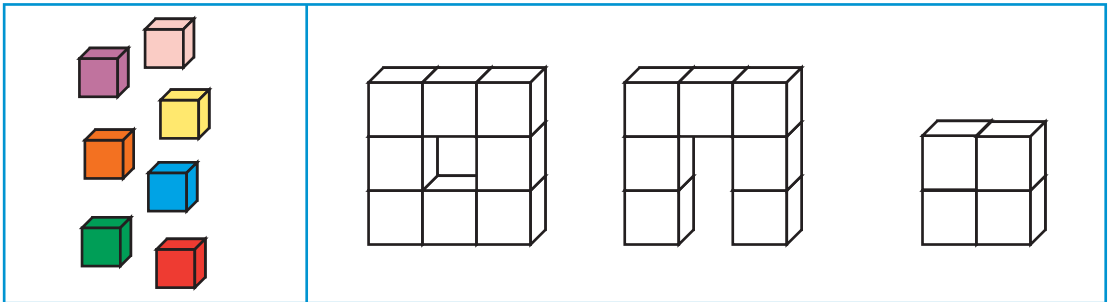
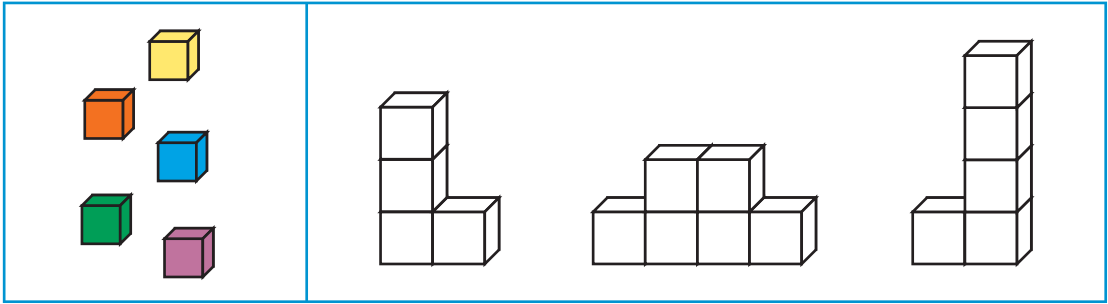

**11. MÕTLE, MILLISED KUJUNDID ON LAOTUD 6 TIKUST.**

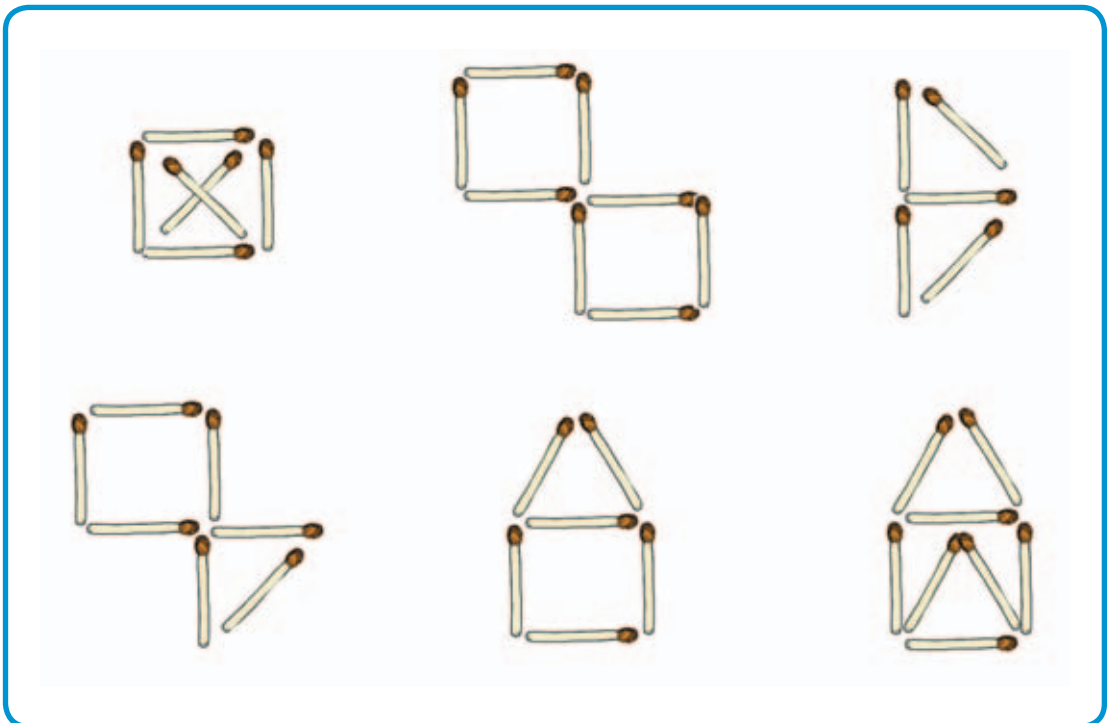

# MATEMAATILINE JUTUKE

1. VÄLJAKUL ON 2 ROHELIST JA 3 KOLLAST KURIKAT. KOKKU ON \_\_\_\_ KURIKAT.



2. PIIA VEERETAS VIIEST KURIKAST 3 MAHA. PÜSTI JÄI \_\_\_\_ KURIKAT.

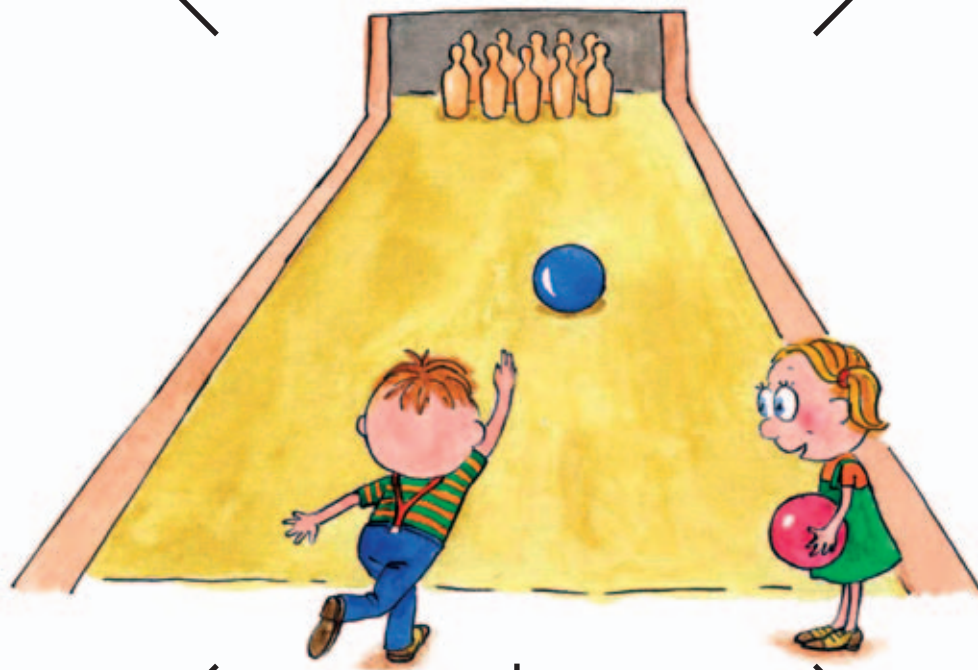

3. VILLU VEERETAS VIIEST KURIKAST 2 MAHA. PÜSTI JÄI \_\_\_\_ KURIKAT.

4. PÄRTEL VEERETAS MAHA 2 ROHELIST JA 3 KOLLAST KURIKAT. PÜSTI EI JÄÄNUD ÜHTEGI.



5. PIIA VEERETAS MAHA \_\_\_\_ KURIKA VÕRRA ROHKEM KUI VILLU.



6. VILLU VEERETAS MAHA \_\_\_\_ KURIKA VÕRRA VÄHEM KUI PIIA.



KOOSTA MATEMAATILISI JUTUKESI.

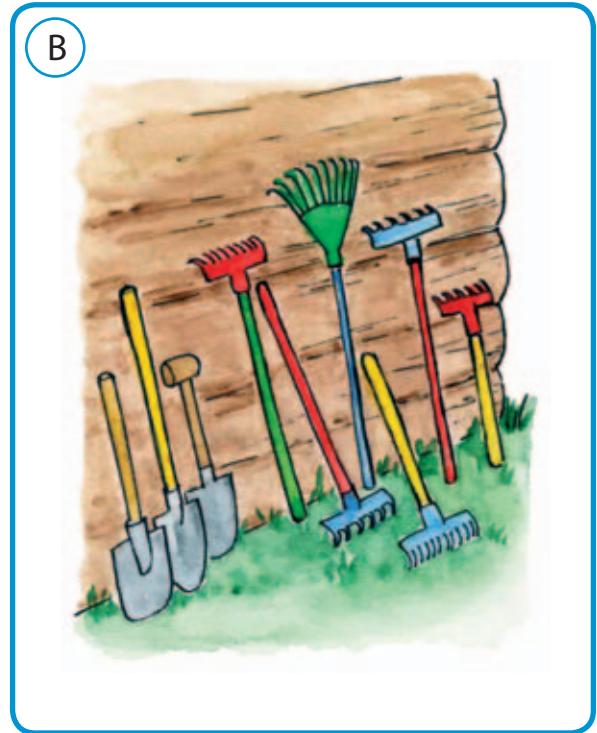
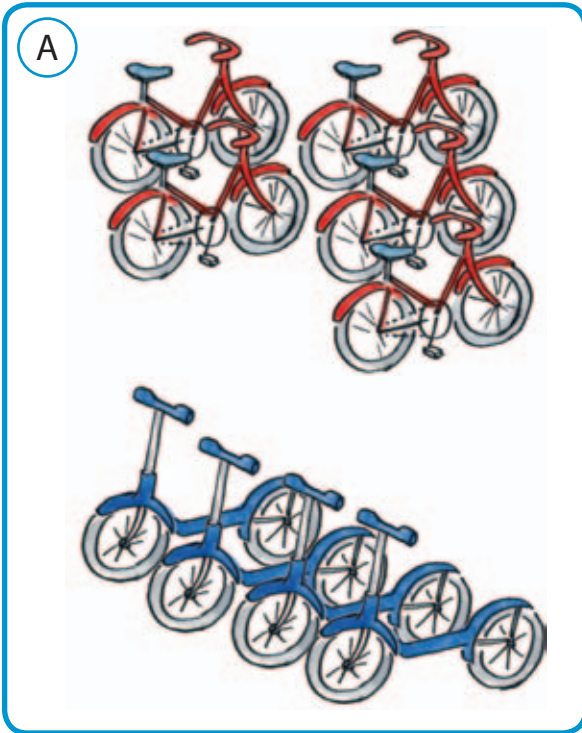



# ARVUD 1 KUNI 6



MIKS SEE PILT?



MIKS SEE  
PILT?

